



ENVIRONMENTAL TECHNOLOGY

HDSS™

Heavy Duty Slurry Seal Range



- **SUITABLE FOR ALL MINING AND MINERAL ORE PRODUCTION APPLICATIONS**
- **CARTRIDGE DESIGNS FOR EASE OF INSTALLATION**
- **ABRASION RESISTANT COMPONENTS**
- **FLUE GAS DESULPHURISATION (FGD) DESIGNS**
- **ULTRA ROBUST SINGLE AND DOUBLE PATENTED DESIGNS**
- **CLOSED CIRCUIT SUPPORT SYSTEMS**

AESSEAL® - "Providing Exceptional Customer Service"



The AESSEAL® Global Technology Centre is the largest of over 50 branches worldwide.

AESSEAL® is one of the leading global specialists in the design and manufacture of mechanical seals and support systems.

Following 24 years of uninterrupted growth, with over 1000 employees operating from 51 locations and with sales to 83 countries, we have become the worlds 4th largest mechanical seal supplier. Growth has been driven through exceptional customer service and innovative products that work.

HDSS™ – heavy duty slurry seal range

AESSEAL® has been sealing slurries successfully for decades throughout many industries, including:-

- Mining
- Minerals Processing
- Water and Waste Water
- Pulp and Paper
- Sugar Refining
- Power Generation
- Chemical Processing
- Flue Gas Desulphurisation

Liquids carrying abrasive particles represent the most common type of slurry applications found in industry. The percentage of solids, concentration and particle size create a combination which will result in abrasion and seal failure, if the correct seal and seal environment is not properly selected.

The AESSEAL® HDSS™ Slurry Seal range of single and double mechanical seals have been designed to excel in these harsh abrasive slurries. Our wide range of seal support systems and bearing protectors compliment the HDSS™ range, allowing our technical experts to offer total packaged solutions for all slurry applications.

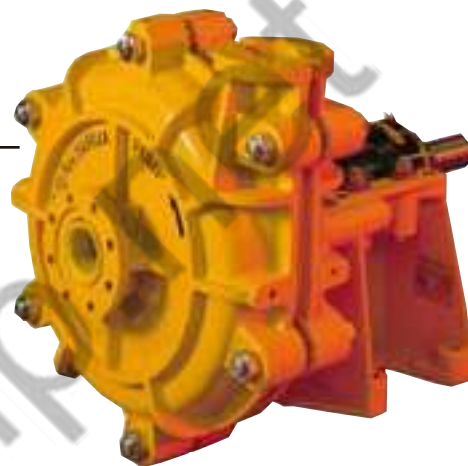

Abrasive single cartridge sleeve damage from inboard seal leakage



Effects of abrasion and erosion on a seal gland plate.



AESSEAL® standard double seal installed on a pump.

Over the years, AESSEAL® have sealed almost all major slurry pump types and models. Solutions for some of the more commonly encountered slurry pump manufacturers include;

Warman®, Denver Orion®, Goulds® and KSB® to name but a few.

By example, the detailed table to the right, shows products available for the full range of Warman® AH pumps.

Warman® Pump Type	Seal Size
1.5 / 1 BAH	50mm
2 / 1.5 BAH	50mm
3 / 2 CAH	60mm
4 / 3 CAH	60mm
4 / 3 DAH	85mm
6 / 4 DAH	85mm
6 / 4 EAH	100mm
8 / 6 EAH	100mm

In practically ALL applications, where our standard products do not directly fit, AESSEAL® will configure and adapt our components to ensure our products install directly into the equipment WITHOUT REQUIRING PUMP MODIFICATIONS.

As well as a comprehensive range of products for slurry pumps, AESSEAL® also offer solutions for other types of slurry equipment such as slurry seals for Cellier and Stelzer mixers.

Systems – can systems optimise your seal performance?

The condition of the fluid film between the Stationary and Rotary seal faces is the MOST IMPORTANT part of any mechanical seal. Processed fluids which either;

- Change state (crystallize) on contact with the atmosphere,
- Are thermo-sensitive and harden or soften when heated,
- Are particularly viscous in that they are unable to penetrate and form a fluid film,

should be sealed by a **double** mechanical seal and seal **support system**.

The following figures show what happens in such conditions when a single seal is used.



AESSEAL® Water Management Systems

Stage 1 Single Seal

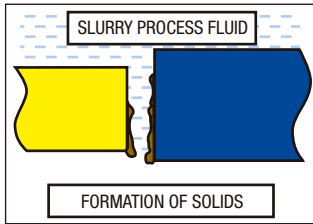

Stage 2 Single Seal

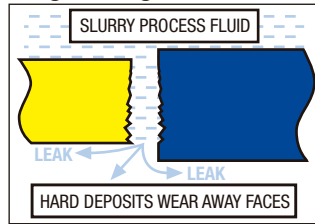

Stage 3 Single Seal

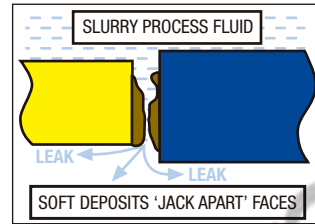

Double Seal

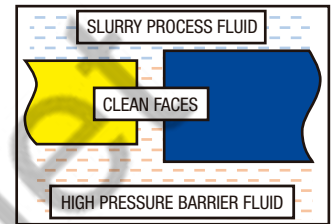

The purpose of a double seal is to change the fluid film environment, ensuring the seal faces run on a clean, cool fluid supplied by a seal management system, as shown top right. This simple yet fundamental concept **WILL** extend the seal life on your plant.

Systems – what about seal support systems in remote dry places?

Clearly, some areas of the world will not have consistent water supply available to support a double mechanical seal therefore single seals are viewed as the only option. Such desolate areas do not come much drier or more remote than the mining industry in North Queensland, Australia.

In Australia, AESSEAL® have installed double mechanical seals in Warman® slurry pumps and extended seal life by over SIX FOLD. The AESSEAL® patented technology employs an integral oil sump within the seal chamber, which requires no maintenance or external services. The simple yet effective innovation of the HDDSS™ bathes and lubricates the seal faces with oil, maximizing their effective life.



Our forced circulation self contained oil systems (PUMPPAC™ and SOU™) are further tools to transform seal life in desolate areas.

HDDSS™ - range of double cartridge seals

FGDDS™ - Flue Gas Desulphurisation Double Seal

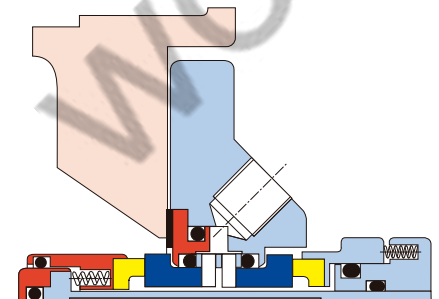

The FGDDS™ is a light to medium slurry cartridge double seal which has found particular success in flue gas desulphurisation sealing applications.

- No requirement for external flushes
- Self-aligning seal faces - inboard and outboard
- Cartridge design
- Pre-set unit for reliable installation
- No shaft fretting
- Non-clogging internal rotary
- Supplied in Alloy C276 as standard

UHDDS™ - Ultra Heavy Duty Double Seal

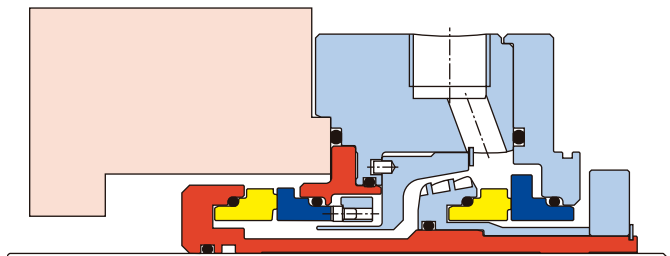

The UHDDS™ is a double cartridge seal particularly applicable for medium to heavy duty slurry sealing applications. The design is offered with a solid tungsten carbide gland insert for ultimate abrasion resistance of the stationary member.

- Tungsten Carbide gland insert for ultimate abrasion resistance
- Very effective bi-directional pumping ring for high pressure barrier, plan 53 fluid containment
- Overcomes seal failure as a consequence of chalking and dry running

HDSS™ - range of double cartridge seals

HDDSS™ - A unique heavy duty double slurry seal, specifically designed to fit all sizes of Warman® pumps.

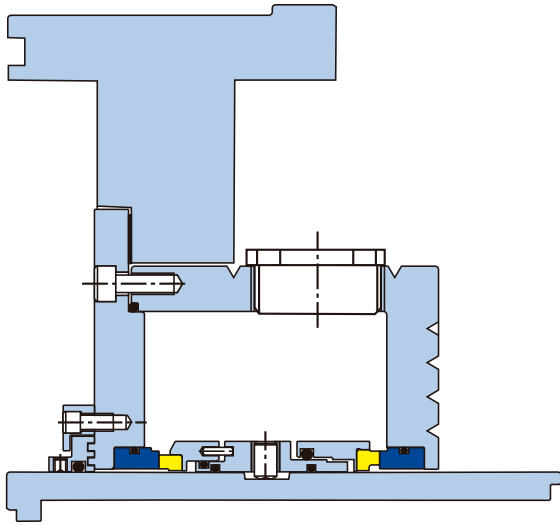

The HDDSS™ is a back to back double seal design which optimises the seal chamber environment. The design has been extremely successful at sealing heavy duty slurries in Australia, specifically on Warman® and Denver Orion® pumps as shown below.

Warman® Frame Size	HDDSS™ SEAL MODEL NO.
'B' Frame	HD BSTSTVW
'C' Frame	HD CSTSTVW
'D' Frame	HD DSTSTVW
'E' Frame	HD ESTSTVW
'F' Frame	HD FSTSTVW
'G' Frame	HD GSTSTVW

Denver Orion® Frame Size	AES SEAL MODEL NO
'D' 100 x 75	HD 10075 DSTSTVO

HDDSS™ - design features

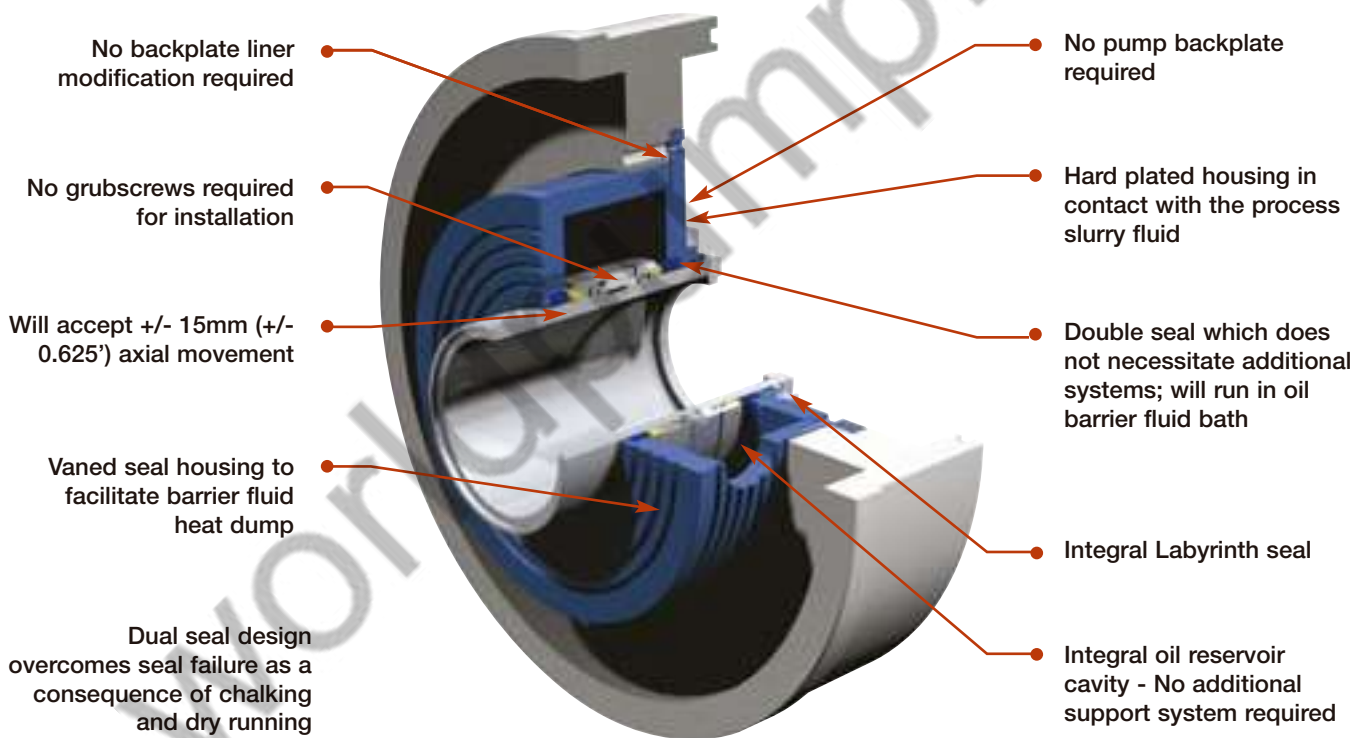

Since the 1990's in Australia the AESSEAL® HDDSS™ Slurry seals have consistently improved seal life, often more than 6 fold, over incumbent competitor seals on Warman® and Denver Orion® pumps.

Documented case references detail a wide range of slurry experience, exemplified by a 15bar (217psi) 3rd stage Beach Sand application in the Titanium Dioxide Extraction industry, where the HDDSS™ seals are installed on Warman® C & D frame pumps operating at 1400rpm. Despite TWO impeller changes, the seals remain in place and leak free.



HDDSS™ cartridge seal.

HDDSS™ - Installation made easy

With decades of experience in sealing slurries across the world, AESSEAL® can offer expert professional help with everything from trouble-shooting to site surveys, from seal and system bespoke designs to on site seal installation support.

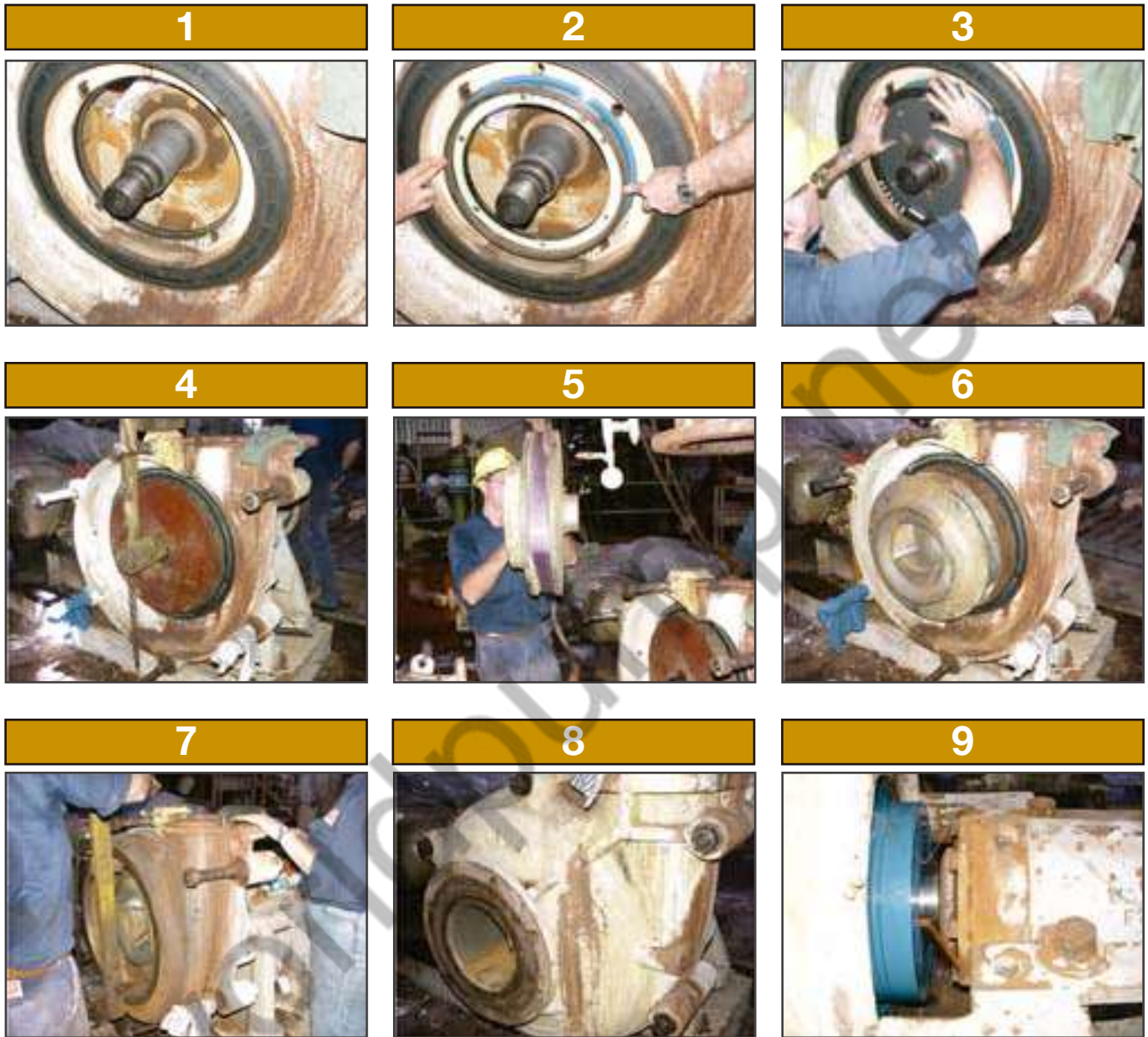

The photos above show the HDDSS™ double cartridge seal being installed on a Warman® slurry pump. The user-friendly nature of the design should be apparent. As shown, the seal does not require a precise pre-installation setting procedure. The seal has no setting clips. It is the ultimate “plug and play” solution.

By their nature, slurry pumps get stripped down all the time to change out impellers and liners. Ideally plant engineers do not want to take the seal off with every strip down. The HDDSS™ will accommodate up to 15mm (0.6”) axial shaft adjustment, without effecting the seal interface load.

As well as providing standard and bespoke products to meet the most demanding applications, AESSEAL's experience in the slurry industry allows them to offer a comprehensive installation and technical advice service.

AESSEAL Australia Pty Ltd. - Queensland, Australia



AESSEAL Pty Ltd - Johannesburg, South Africa.

HDSS™ - range of single cartridge seals

SMSS SLURRY™ - single cartridge seal

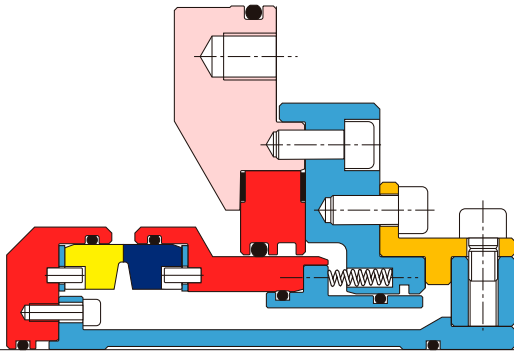

The SMSS SLURRY™ seal is a stationary monolithic seal face single cartridge seal designed for low to medium slurry applications.

The multiple springs, which energize the stationary seal face, are shrouded to prevent clogging as a result of leakage from the inboard seal faces.

- Multiple springs out of product for homogeneous fluid film
- Multiple springs shrouded to prevent clogging
- Abrasion resistant wetted components
- High pressure capability

CVSD™ - Cartridge Seal with Vulcanized Spring Disk

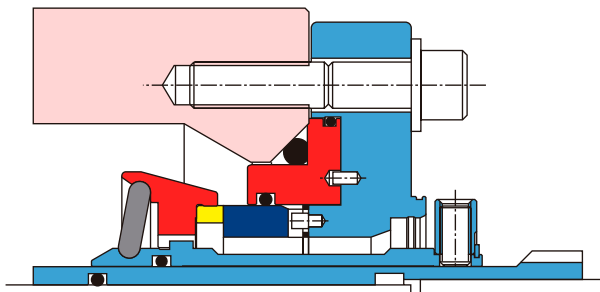

The CVSD™ is a single cartridge seal designed for medium to heavy duty slurry applications. The design employs an anti-clogging vulcanized spring disk rotary member in contact with the process media.

As standard, the gland insert is offered in an abrasion resistant material and the gland is supplied without a flush connection.

- Conventional slurry seal design
- Abrasion resistant insert
- Large internal clearances
- Optional external seal for Plan 62 Quench to Drain applications

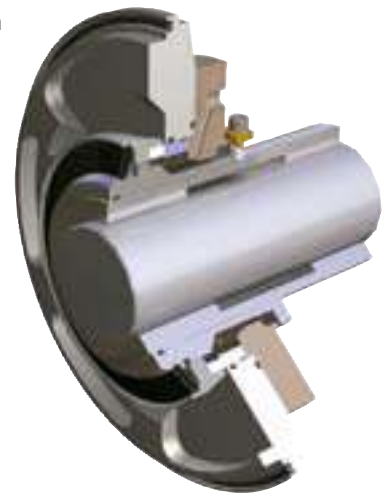

CVSD™ with AESSEAL® specifically designed pump gland plate.



CVSD™ installed on a Slurry pump.



Common problems using single seals or packing in slurry applications

There are many issues surrounding the use of single seals and packing on slurries. Some of the main ones are described below;

- All seals leak. Single seals operating without a flush will ultimately leak slurry fluid across the seal faces, the faces will jack apart until leakage is intolerable.
- Over a period of time, it is common for slurries to chalk the flush line pipework. This will lead to flush starvation in the seal, which ultimately leads to dry running and seal face failure.
- Gland packing in high-pressure slurry pumps can "slime out". This means the packing fails dramatically and almost instantaneously. Apart from the clear health and safety implications to nearby plant operatives, the leaking slurry then cuts the pump bearing housing to pieces, or at best, it penetrates into the bearing housing in a matter of minutes and destroys the bearings.



Gland packing 'slime out' consequences

Seal Support Systems – changing the environment

Any high performance double mechanical seal demands a high performance barrier fluid system to maximize the performance envelope. AESSEAL® has a wide range of standard environmental support systems for all operating parameters. Full technical specifications are available on request: systems@aes seal.co.uk



PUMPPAC™ Range - High duty self contained forced lubrication system available in oil and water formats.



AES15™ Range - High pressure water support system.



SWFF-TF™ Water management range - Unpressurized and pressurized water systems.



AESSEAL® water management system on slurry pump duty.

Slurry Sealing – changing the environment when using single seals

Cyclone Separator

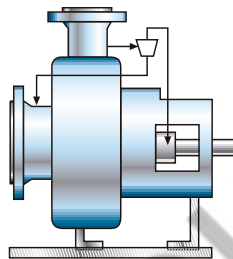

PLAN 31

The AESSEAL® Cyclone separator can be used in conjunction with the full range of AESSEAL® HDSS™ seals typically in plan 31. It is particularly useful in conjunction with the SMSS SLURRY™ and CVSD™ single seal designs when used in conjunction with a closed frame plate liner to reduce abrasive particulate content around the seal faces.

FLOW TRUE™

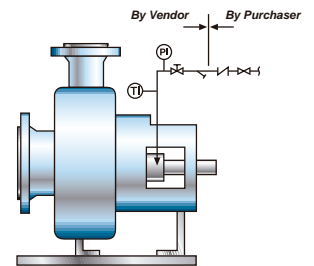

PLAN 32

When there is an abundant supply of water and/or added water into the product media complements the process, the use of a flush injected from an external source (Plan 32) is a suitable method to change the seal face environment.

AESSEAL® can supply The FLOW TRUE™ and orifice plates for Plan 32 systems allowing the user to monitor and regulate the flow at the seal faces.

Seal Chamber Vortex Breakers

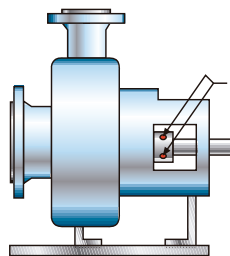

PLAN 02

Standing vortices in the seal chamber are the main causes of gland plate abrasion / erosion in slurry duties.

As part of the seal package, AESSEAL® offer bespoke gland plate designs containing integral vortex breakers which help to break down the standing vortices. This can increase seal life.

FLOW FUSE™

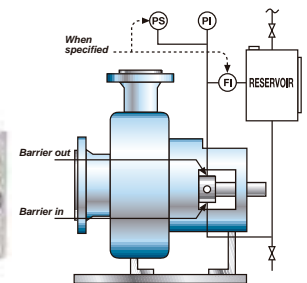

PLAN 53

Some slurries are fluid sensitive and hence the use of a double seal and support system is discouraged by site engineers as inboard face leakage would contaminate their process.

In such cases, AESSEAL® offer their patented Flow Fuse design, integral to their water management system. The Flow Fuse shuts down the flow of barrier fluid into the slurry within seconds of sensing an inboard seal face upset condition, resetting itself once the upset condition has passed.

Don't forget - correct primary sealing is only half the battle!

If your pump looks like this...



Your bearings will soon look like this



or a MagTecta™ bearing protector?



...and improve your **UPTIME!**

... then Protect them with a Lip Seal...



...and **KILL** your shaft and your bearing?

Bearings last longer when they are Protected!

See www.magtecta.com for further details.

THIS DOCUMENT IS DESIGNED TO PROVIDE DIMENSIONAL INFORMATION AND AN INDICATION OF AVAILABILITY. FOR FURTHER INFORMATION AND SAFE OPERATING LIMITS CONTACT OUR TECHNICAL SPECIALISTS AT THE LOCATIONS BELOW.



INVESTOR IN PEOPLE

USE DOUBLE MECHANICAL SEALS WITH HAZARDOUS PRODUCTS. ALWAYS TAKE SAFETY PRECAUTIONS:

- GUARD YOUR EQUIPMENT
- WEAR PROTECTIVE CLOTHING



WARNING

Australian Sales & Technical advice:
AESSEAL Australia Pty Ltd.,
12 Counihan Road
Seventeen Mile Rocks
Queensland
4073
Australia

Tele: +61 7 32791 144
Fax: +61 7 32791 067
E-mail: sealtech@powerup.com.au

Distributed by:

UK Sales & Technical advice:

AESSEAL plc
Mill Close
Templeborough
Rotherham, S60 1BZ
United Kingdom

Telephone: +44 (0) 1709 369966
Fax: +44 (0) 1709 720788
E-mail: seals@aes seal.com
Internet: <http://www.aes seal.com>

Copyright © 2006 AESSEAL plc

AES / DOC / IN 4981 05/2006

HDSS™, HDDSS™, CVSD™, SMSS SLURRY™, FGDDSS™, MagTecta™, AES15™, Pumpac SOU™, FF-TF™, FLOWTRUE™, FLOWFUSE™ and Pumpac™ are Trademarks of AESSEAL plc
Registered Trademarks: AESSEAL® - AESSEAL plc
WARMAN® is a trade mark of Weir Minerals Australia Ltd.
Denver Orion® is a trade mark of SVEDALA
Goulds® is a trade mark of IIT Industries
KSB® is a trade mark of KSB Aktiengesellschaft
All other brand and product names are trademarks or registered trademarks of their respective holders.

ALL SIZES ARE SUBJECT TO MANUFACTURING TOLERANCES. WE RESERVE THE RIGHT TO MODIFY SPECIFICATIONS AT ANY TIME.

Reference Issue • L - AU - HDSS - 01